

SYM.	DATE	DESCRIPTION	REV. BY
------	------	-------------	---------

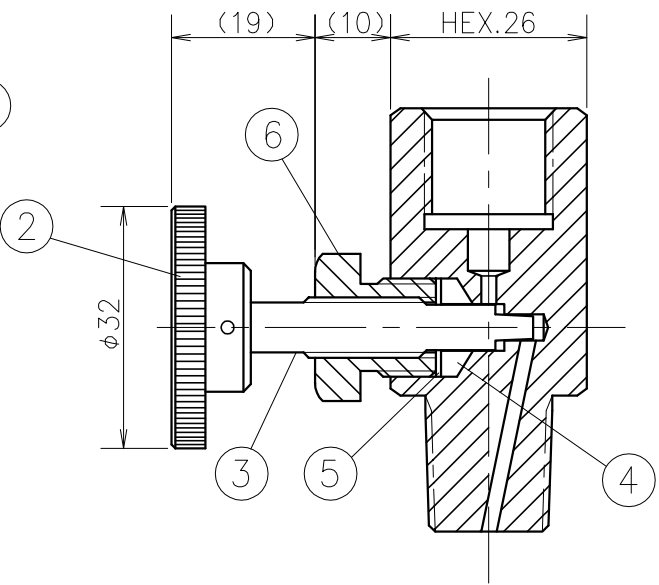
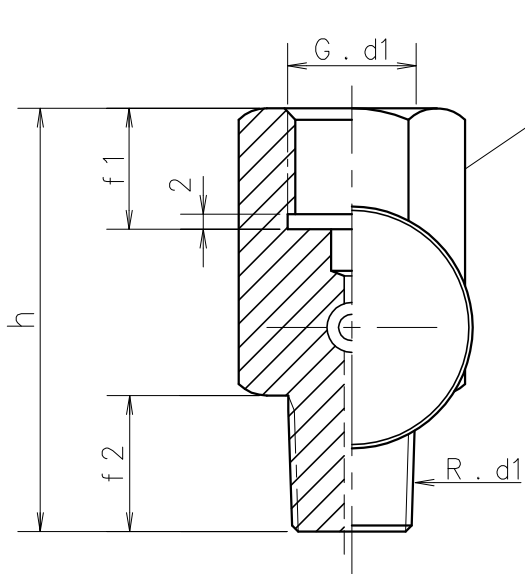
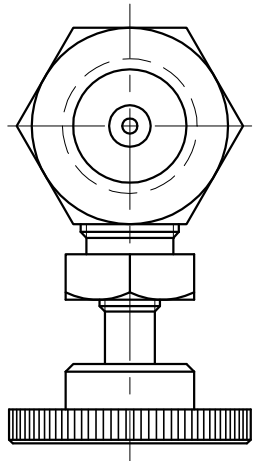

d1	f1	f2	h
1/4	14	14	52

Max. Pressure Liquid
 最高使用圧力 : 20 MPa
 Max. Test Pressure
 耐圧試験圧力 : 30 MPa
 Fluid
 使用流体 : 液体
 Temperature
 使用流体温度 : 0 ~ 80 °C

⑥	Nut ナット	SUS303	
⑤	Washer ワッシャ	SUS304	
④	Packing パッキン	PTFE	
③	Spindle 調整軸	SUS303	
②	Handle ハンドル	C3604B	Cr Plating クロムメッキ
①	Body 本体	C3604B	

Order No. 貴注番	
Quantity 台数	
Remarks 備考	

MATERIAL 材質	DESIGNED FOR 品名 Dampener ダンブナ (G1/4×R1/4)	PLATES NO. 品番	MODELS TO BE USED	QTY.
FINISH 処理	MODEL AND SIZE 型名 ZKV-2	DATE 2025.02.13	CHKD. KONTANI	
SCALE 尺度 Free	TOLERANCE 公差 ±	DRWN. HONDA	APPD. TANABE	
TITLE 図名 Outside Drawing 外形図		DRWG NO. 図番 KV2B-002		

